

THIS DRAWING OR SPECIFICATIONS CONSTITUTES THE CONFIDENTIAL INFORMATION OF GATES-MECTROL. A TOMKINS COMPANY AND ITS RECEIPT OR POSSESSION DOES NOT CONVEY ANY RIGHT IN OR LICENSE TO USE IT OR THIS INFORMATION DISCLOSED HEREIN NOR ANY RIGHT TO REPRODUCE THIS DRAWING OR SPECIFICATION NOR ANY PART HEREOF WITHOUT THE WRITTEN CONSENT OF GATES-MECTROL. A TOMKINS COMPANY

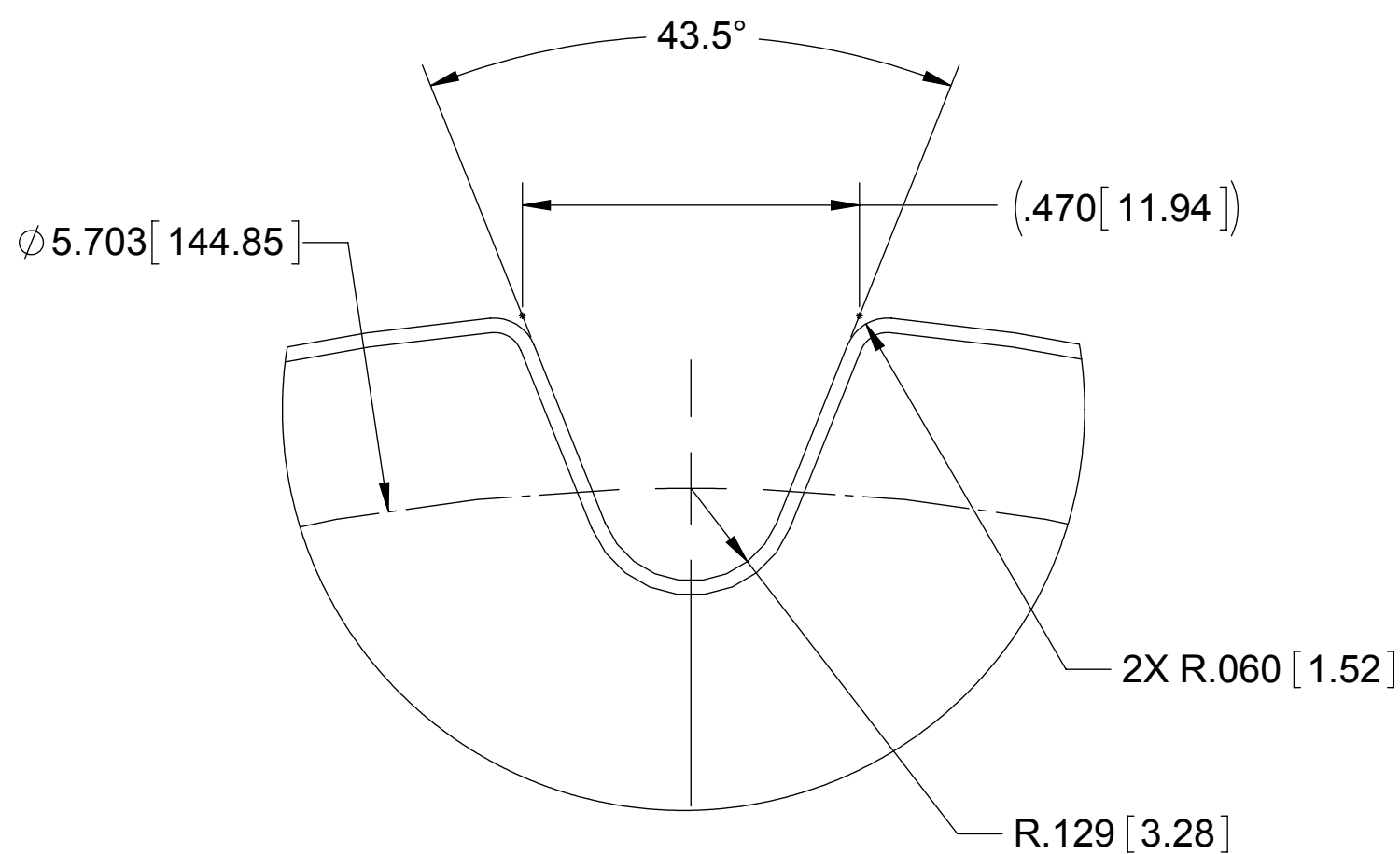
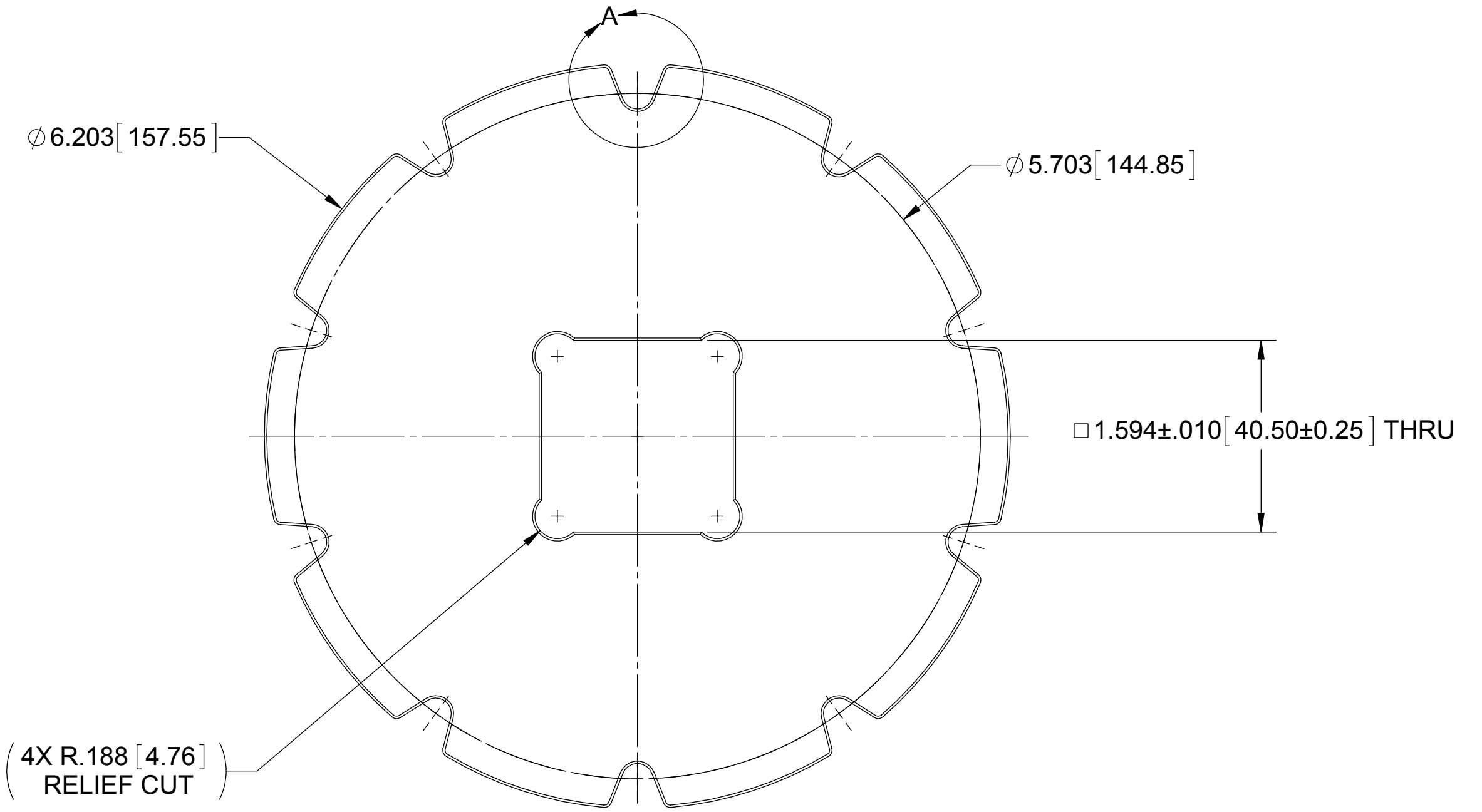
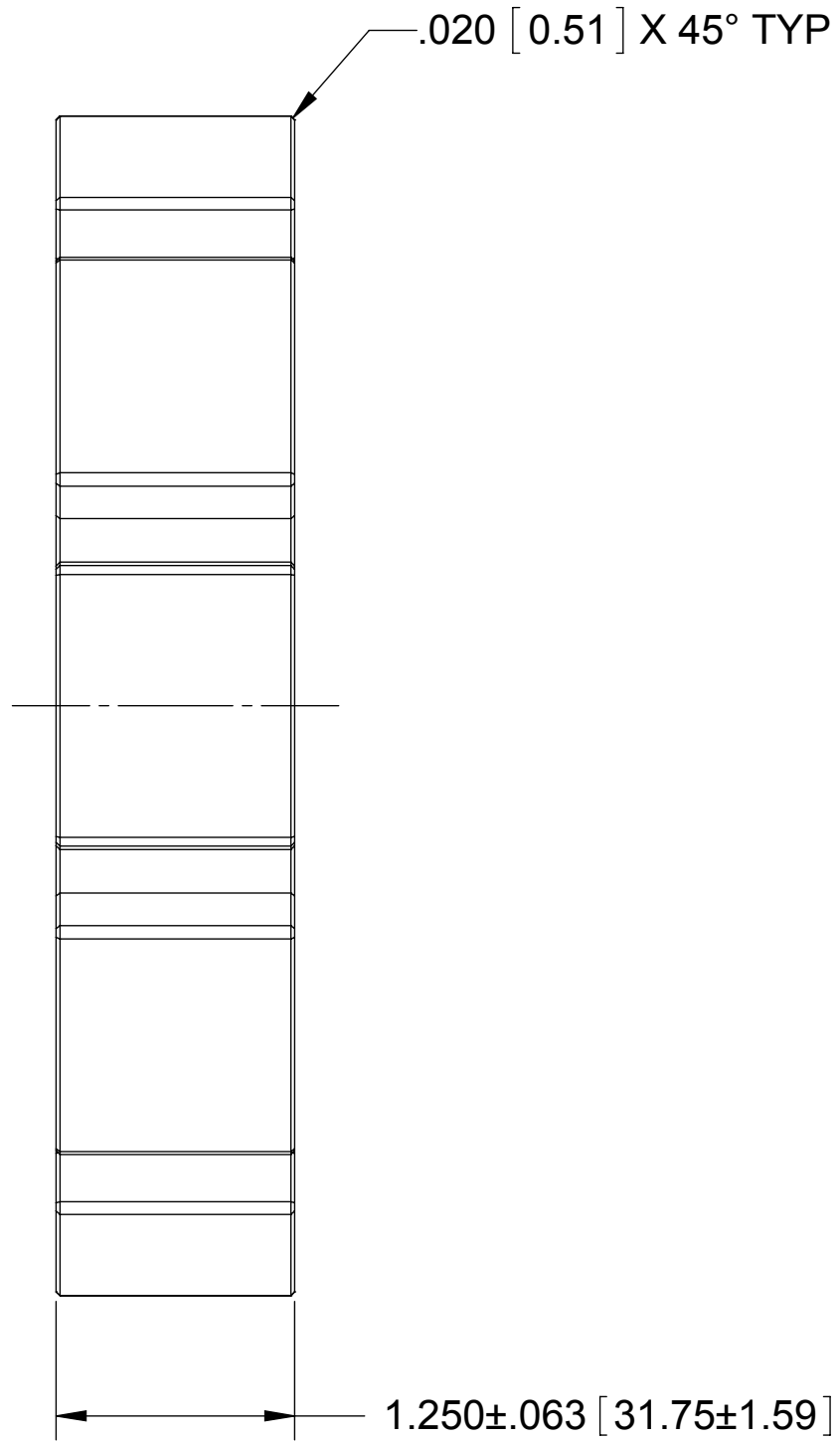

DETAIL A
SCALE 4 : 1
GROOVE GEOMETRY
IS TYPICAL

NOTES:
1. REMOVE ALL BURRS AND SHARP EDGES.

<p>THIRD ANGLE PROJECTION</p>			DRAWN	MWS
	<p>10 TOOTH POSICLEAN 20 SQUARE METRIC BORE PULLEY</p>		SCALE	DATE
<p>TOLERANCES UNLESS OTHERWISE NOTED</p> <p>FRACTIONAL: ±1/64" ANGULAR: ±1/2° FINISH: 32 RMS</p>		<p>1:1</p>		2-17-14
<p>DECIMAL TOLERANCES: INCHES (MILLIMETERS)</p> <p>.XX [X.X]: ±.02 [0.5] .XXX [X.XX]: ±.010 [0.25]</p>		<p>CHECKED</p>		DATE
		<p>MATERIAL</p>		UHMW
		<p>FINISH</p>		
<p>SHEET 1 OF 1</p>		<p>C PSM40PC20100FU</p>		REV -